

# retigo®

PERFECTION IN COOKING AND MORE...

## Combi oven **Orange Vision**

USER'S MANUAL USA / CAN - ORIGINAL EN



# CONTROL PANEL

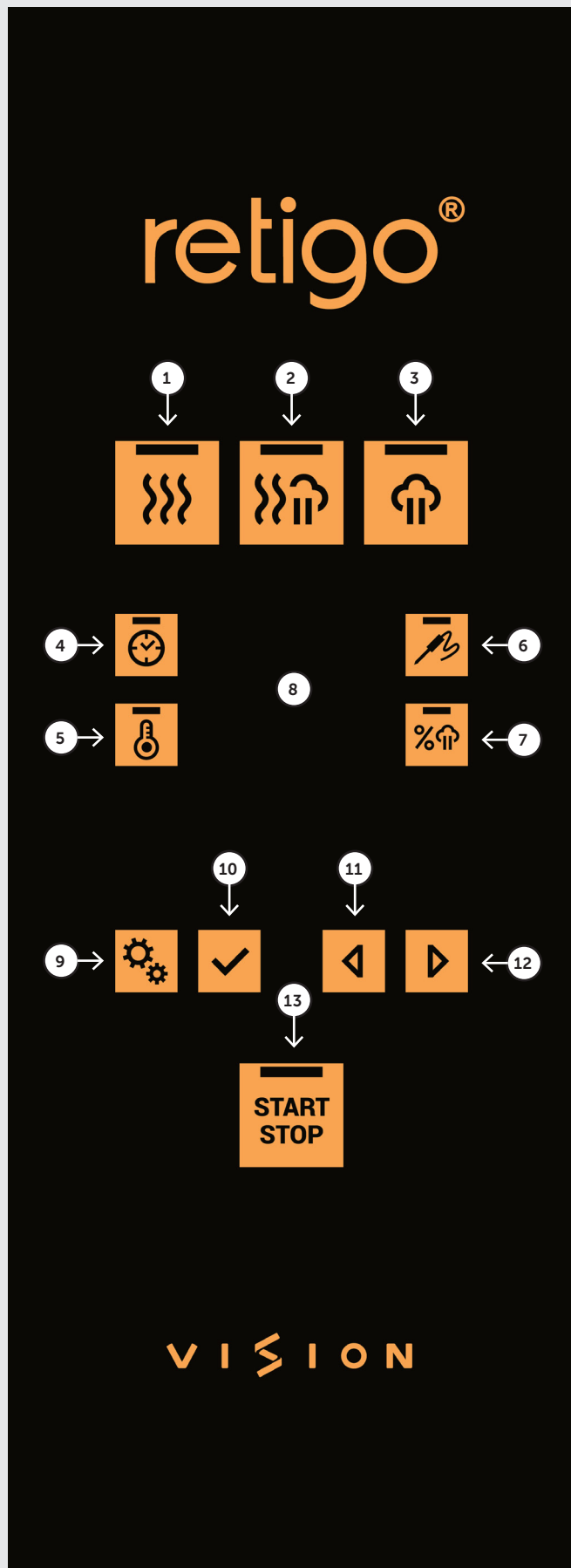

- |    |                                 |
|----|---------------------------------|
| 1  | HOT AIR MODE                    |
| 2  | COMBINATION MODE                |
| 3  | STEAMING MODE                   |
| 4  | TIME                            |
| 5  | TEMPERATURE IN COOKING CHAMBER  |
| 6  | CORE PROBE TEMPERATURE          |
| 7  | LEVEL OF MOISTURE               |
| 8  | DISPLAY WITH ACTUAL VALUES      |
| 9  | FUNCTIONS / BACK                |
| 10 | CONFIRMATION / ENTER            |
| 11 | LEFT ARROW                      |
| 12 | RIGHT ARROW                     |
| 13 | START / STOP OF CURRENT PROCESS |

---

# SAFETY INSTRUCTIONS

## FOR YOUR SAFETY

Do not store or use gasoline or other flammable vapors and liquids in the vicinity of this or any other appliance.



### WARNING

Improper installation, adjustment, alteration, service or maintenance can cause property damage, injury or death.

Read the installation, operating and maintenance instructions thoroughly before installing or servicing this equipment.

Make sure not to obstruct the flow of combustion and ventilation air.



### WARNING

Disconnect power at the main external power switch before servicing or repairing the combi oven.



### WARNING

To reduce the risk of electric shock, do not remove or open cover. No user serviceable parts inside. Refer servicing to qualified personnel. Disconnect power supply before servicing.

IT IS COMPULSORY TO POST INSTRUCTIONS WHICH ARE TO BE FOLLOWED IN THE EVENT THE USER SMELLS GAS. THESE INSTRUCTIONS MUST BE LOCATED IN A PROMINENT LOCATION, AND BE FULLY UNDERSTOOD BY ALL USERS OF THIS EQUIPMENT. THIS INFORMATION NEED TO BE OBTAINED FROM YOUR LOCAL GAS SUPPLIER.

ALL SERVICE MUST BE PERFORMED BY A QUALIFIED RETIGO AUTHORIZED TECHNICIAN. KEEP AREA FREE AND CLEAR OF COMBUSTIBLES.

## Installation

- Installation of this unit must be done by a licensed professional when installed in the Commonwealth of Massachusetts.
- The wiring diagram is located on the inner part of the side panel.

## Customer documentation

- The customer documentation is part of the combi steamer.
- Keep the customer documentation manuals handy at all times so that you can look up any required information.
- Keep the customer documentation manuals for the entire life of the unit.
- Carefully read the installation manual, the operating manual, and the operating instructions before using, handling, and working on this unit.
- If you transfer the combi steamer to a new owner, make sure to give the new owner the customer documentation manuals as well.

---

# CONTENT

|  |           |
|--|-----------|
| FOREWORD.....  | 5         |
| ABOUT THIS MANUAL.....   | 6         |
| <b>1   BASIC INFORMATION ABOUT THE COMBI OVEN.....</b>             | <b>7</b>  |
| 1.1 USE: ITS PURPOSE.....  | 7         |
| 1.2 INTRODUCTION: MAIN PARTS.....                                  | 7         |
| 1.3 OPTIONAL EQUIPMENT.....  | 7         |
| 1.4 CONTROLS: BASICS.....  | 8         |
| <b>2   SAFETY DURING USE.....</b>                                  | <b>9</b>  |
| 2.1 SAFE OPERATION.....  | 9         |
| 2.2 PROTECTIVE AIDS.....   | 10        |
| 2.3 PROTECTIVE ELEMENTS OF THE COMBI OVEN.....                     | 10        |
| 2.4 DANGEROUS LOCATIONS AND RESIDUAL HAZARDS.....                  | 11        |
| <b>3   OPERATION.....</b>  | <b>14</b> |
| 3.1 CONTROL PANEL.....   | 14        |
| 3.2 DESCRIPTION OF THE BUTTONS.....                                | 14        |
| <b>4   COOKING.....</b>  | <b>15</b> |
| 4.1 SETTING COMBI OVEN FUNCTIONS BEFORE STARTING COOKING.....      | 15        |
| 4.2 MANUAL SETTINGS.....   | 16        |
| 4.3 PROGRAMS (optional accessory).....                             | 17        |
| <b>5   SETTINGS.....</b>   | <b>24</b> |
| 5.1 USING THE SETTINGS MENU.....                                   | 24        |
| 5.2 INDIVIDUAL ITEMS IN THE SETTINGS MENU.....                     | 25        |
| <b>6   AUTOMATIC Cleaning.....</b>                                 | <b>30</b> |
| 6.1 BASIC INFORMATION AND WARNINGS.....                            | 30        |
| 6.2 STARTING THE Cleaning.....                                     | 31        |
| <b>7   MAINTENANCE.....</b>  | <b>33</b> |
| 7.1 DAILY MAINTENANCE.....   | 33        |
| 7.2 MONTHLY MAINTENANCE.....                                       | 34        |
| <b>8   ERROR MESSAGE TABLE.....</b>                                | <b>35</b> |
| <b>9   SERVICE LIFE, TAKING OUT OF OPERATION AND WARRANTY.....</b> | <b>37</b> |

## FOREWORD

Dear customer,

Thank you for purchasing a product from Retigo s.r.o. We are a manufacturer and supplier of specialised professional culinary appliances with a long track record of success. We believe this appliance will help you implement your ideas with outstanding results in your daily work. With this appliance, you can produce meals of such quality that your customers will come back again and again.

We wish you great joy and success in using the ORANGE VISION combi oven.

# ABOUT THIS MANUAL

This manual will help you to easily understand how to operate the ORANGE VISION combi oven and inform you about its options and capabilities.

### SYMBOLS USED IN THIS MANUAL

In this user's manual you will find symbols with the following meaning:

| SYMBOL | MEANING   |
|--------|---|
|        | These symbols mean "ATTENTION" and "WARNING", they inform you about things that may cause serious injury to the user and/or damage to the machine. Furthermore, they indicate an important instruction, feature, method or issue that must be followed or considered when operating or maintaining the appliance. |
|        |   |
|        | This symbol indicates useful information related to the appliance or its accessories.   |
|        | This symbol refers to a different chapter of the manual.  |
|        | Inform about other procedure options that you may, but not necessarily utilise.   |

### WHO IS THE MANUAL FOR?

This manual is intended for anyone who comes into contact with the appliance only during its maintenance or operation. Each person must be thoroughly acquainted with its contents before beginning any work with the appliance.

### IMPERATIVE

It is essential that the manual is considered as a part of the appliance, which must not be separated from it. For this reason, store it for future use.

Study the manual carefully. It must be considered to be a part of the appliance that must not be separated from it upon resale. For this reason, store it for future use.

Follow its instructions exactly, not only to make using the appliance easier, but also to ensure its optimal use and long life.

Do not start the appliance unless you are thoroughly acquainted with all instructions, prohibitions, recommendations indicated in this manual, especially those in the chapter "Safety during use".

The illustrations in this manual may not always correspond to the actual appliance. Their purpose is to describe the appliance's main principles.



The complete technology documentation for the appliance can be found at the manufacturer's website.

### WHEN IN DOUBT

In practice, unforeseeable situations frequently arise that cannot be included and described in this user's manual. Therefore, when you're not sure what to do, always contact the manufacturer:

RETIGO s.r.o.

Láň 2310

756 61 Rožnov pod Radhoštěm

**+420 571 665 511**

**INFO@RETIGO.CZ**

**WWW.RETIGO.COM**

When contacting the manufacturer or trained professionals, please have your combi oven's basic information ready.

This can be read from the model plate located on the upper right side.

It provides details about the combi oven's manufacturer, technical data, such as type and model, serial number, year of manufacture, and important information about the type of power supply, weight and water protection class.

Láň 2310, PS 43  
CZ-756 64 Rožnov p. R.  
Tel. +420 571 665 511  
e-mail: info@retigo.com  
www.retigo.com

|   |  |
|---|--|
| <b>TYPE:</b><br>TYPE:                               | <b>VOLTAGE:</b><br>TENSION:              |
| <b>MODEL:</b> 2U VVVWX<br>MODELE:                   | <b>CURRENT:</b><br>COURANT:              |
| <b>SERIAL No.:</b><br>NUMÉRO DE SÉRIE:              | <b>PHASE:</b><br>PHASE:                  |
| <b>MFG DATE:</b><br>DATE DE FABRICATION:            | <b>POWER:</b><br>PUISSANCE:              |
| <b>WEIGHT:</b><br>POIDS:                            | <b>FREQUENCY:</b><br>LA FRÉQUENCE:       |
| <b>HEAT LOAD MAX:</b><br>PUISSANCE THERMIQUE - MAX: | <b>SUPPLY PRESS:</b><br>PRESSION DU GAZ: |
| <b>HEAT LOAD MIN:</b><br>PUISSANCE THERMIQUE - MIN: | <b>GAS TYPE:</b><br>TYPE DE GAZ:         |

**MAXIMUM CAPACITY:**  
POIDS MAX DE L'ALIMENT:

X98-0160-R03

**MODEL**

**CLASSIFIED**  
  
**LISTED**

**SERIAL NUMBER**

**UL**  
  
**UL**

**COOKING EQUIPMENT**  
 E483211  
**NSF/ANSI 4**  
ANS Z33.11 • CSA 1.8-2016 Food Service Equip.

Láň 2310, PS 43  
CZ-756 64 Rožnov p. R.  
Tel. +420 571 665 511  
e-mail: info@retigo.com  
www.retigo.com

|  |                                    |
|--|------------------------------------|
| <b>TYPE:</b><br>TYPE:                    | <b>VOLTAGE:</b><br>TENSION:        |
| <b>MODEL:</b> 2U VVVWX<br>MODELE:        | <b>CURRENT:</b><br>COURANT:        |
| <b>SERIAL No.:</b><br>NUMÉRO DE SÉRIE:   | <b>PHASE:</b><br>PHASE:            |
| <b>MFG DATE:</b><br>DATE DE FABRICATION: | <b>POWER:</b><br>PUISSANCE:        |
| <b>WEIGHT:</b><br>POIDS:                 | <b>FREQUENCY:</b><br>LA FRÉQUENCE: |

**SUPPLY CONNECTIONS:**

**MAXIMUM CAPACITY:**  
POIDS MAX DE L'ALIMENT:

X98-0138-R05

**MODEL**

**CLASSIFIED**  
  
**LISTED**

**SERIAL NUMBER**

**UL**  
  
**UL**

**COMMERCIAL COOKING APPLIANCE**  
 E151437  
**COOKING EQUIPMENT**  
 E329633  
**NSF/ANSI 4**

# 1 | BASIC INFORMATION ABOUT THE COMBI OVEN

## 1.1 USE: ITS PURPOSE

The ORANGE VISION combi oven is a universal appliance for preparing meals, including complete menus. It can be used for all types of food preparation methods based on heat, for example baking, frying, grilling, stewing, steam cooking, low-temperature overnight cooking, etc. The process is performed either in manual mode or in automatic mode utilising programs.

### INTENDED USE OF THE COMBI OVEN

- The equipment can be used only for heat preparation of various types of food. This involves steam, hot air or a combination of the two. The food must always be placed in a standardized cooking container, baking trays dimensioned for baking or standard accessories exclusively from the manufacturer.
- The equipment used must be made of stainless steel, ceramics, heat-resistant plastic or enamelled steel.
- The combi oven is exclusively for professional use in the culinary field.

### CORRECT USE OF THE COMBI OVEN

The following must not be placed inside the combi oven:

- no food in closed cans or packages
- no easily combustible objects with an ignition point lower than 500 °F, such as easily combustible oils, fats or cloths
- no dry powder or granulate

## 1.2 INTRODUCTION: MAIN PARTS

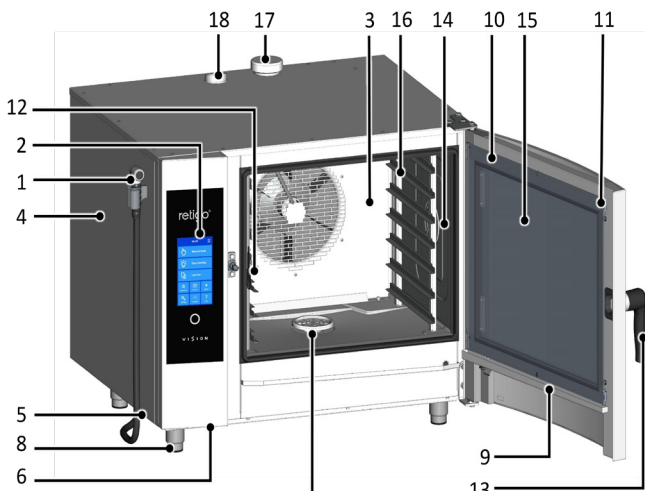

1. Self-winding hand shower – The standard configuration includes a shower hung on the left side of the machine.
2. Control panel
3. Detachable interior wall in front of fan
4. Side cover
5. Air and dust filter

6. USB connector
7. Drain cover
8. Height-adjustable legs
9. Condensation drip pan for the inner glass with automatic draining
10. Door with rounded exterior glass
11. Bolts for gripping interior glass
12. Temperature probe
13. Door handle
14. Interior lighting
15. Interior opening glass on door
16. Rail racks for cooking containers – Sizes 2011, 1221, 2021 have a loading trolley instead of rail racks.
17. Excess steam venting flap
18. Vent flue



**Any use of the combi oven including modifications to safety or operational components, is considered unintended use. The company accepts no liability for damages due to such use; the user bears all risk.**

**The user is also responsible for abiding by the conditions prescribed by the manufacturer for installation, operation and maintenance of the appliance, which must be maintained and repaired only by persons familiar with it and instructed on its hazards.**

## 1.3 OPTIONAL EQUIPMENT

The ORANGE VISION combi oven is equipped with automatic cleaning, core probe and flap valve.

Optionally you can have:

- 99 programs

### Accessories

#### GASTRONORM PANS AND BAKING TRAYS

Gastronorm pans and baking trays serve not only as containers for cooking and baking, but are also suitable for transporting, serving and storing the meals. They significantly contribute to higher work efficiency - when one plans their work properly, it is often unnecessary to transfer cooked or baked meals from one pan or tray to another.



Adhere to workplace safety codes when handling gastronorm pans, see 2. SAFETY DURING USE.

### **STANDS, RIDE-IN TROLLEYS AND BRACKETS**

Essential accessories for the combi oven include various stainless steel stands, wall brackets (on model 623) and ride-in trolleys (on sizes 1011, 2011, 1221, 2021). Special equipment is considered to be banquet baskets, trolleys and thermoboxes used for serving meals.

## **1.4 CONTROLS: BASICS**

### **TURNING ON AND OFF**

The combi oven is permanently connected to the power grid and it is turned on and off by pressing an external main power switch. Its location is determined by the operator of the combi oven upon its installation and you as the user must be informed about its location. During standard use, when you have finished using it, it is sufficient to put into standby mode by long pressing the Start/Stop button.

### **OPENING AND CLOSING THE DOOR**

The combi oven's door is equipped with a closing mechanism that allows right- or left-handed opening. Moving the lever to the side will release the door latch. Pull on the handle to open the door.

To close the door, push on the handle (by slamming). If you have an appliance with the ride-in trolley (2011, 1221, 2021) close the door and turn the door handle clockwise by 90°.

### **PREHEATING THE BOILER** (combi ovens with a boiler)

When the combi oven is turned on, the boiler is automatically filled with water which is then heated. For this time, the start of the program will be temporarily disabled in the "Steam" and "Hot air with steam" modes, until the boiler is fully heated. After this time, the combi oven will automatically continue running.



## 2 | SAFETY DURING USE

The combi oven cannot be operated without a certain amount of caution, alertness and common sense. Even though the combi oven has been designed and manufactured to meet all international safety standards, the user bears primary responsibility for his or her safety while operating the combi oven. The manufacturer bears no responsibility for personal injury, equipment damage or environmental damage caused by failure to operate the combi oven according to the manual or by failure to follow applicable safety regulations.

This chapter provides the most important information on working safely and protecting the health of the user and all others who come into contact with the combi oven or its accessories.

### 2.1 SAFE OPERATION

#### GENERALLY

- The combi oven may only be used by personnel authorised, qualified and trained for operating it. Persons who are not authorised to use and have not been trained in its operation must never be allowed to handle or maintain it, or to perform any activity contrary to its use. Such unprofessional activity may cause injury or damage the appliance.
- Get regular training on how to operate the combi oven. This prevents occupational injuries and damage to the combi oven.
- This combi oven is to be used only for food preparation and in compliance with the manual. Any other use is in conflict with its purpose and is considered dangerous.
- For safety reasons, do not remove the hard covers or try to get inside the combi oven - risk of injury by electrical shock. The device contains no components that the user can handle. Repair of any defects or maintenance beyond that described in this manual must be done by a qualified service technician.
- Do not install any heated equipment in the immediate area of the combi oven (such as fryers, grills, cookers, hot plates, etc.).



Detailed requirements for placing the appliance are given in the instructions for transport and installation.

- Do not work with the combi oven if you suffer from dizziness, fainting or other weakness or lack of concentration or if under the influence of drugs or alcohol!
- It is strictly forbidden to remove or damage the labels fastened to the combi oven.
- Only operate the combi oven in perfect working order. Do not make any changes to it.
- Follow the prescribed inspection plan, follow the instructions in the operating manual, adhere to generally valid regulations for gas appliances.
- Do not place any items in the vicinity of the combi oven, which you could trip over. Keep the workplace (including access ways) clean and tidy.

#### COMBI OVEN OPERATING ENVIRONMENT

- The permitted ambient temperature range is +39,2°F to +95°F.
- The environment must not be explosive or toxic.
- A fire extinguisher or an automatic fire extinguishing system must not be located directly above the combi oven.
- There must be no flammable materials, gasses or liquids located underneath or next to the combi oven.

#### BEFORE USING THE COMBI OVEN

- Before starting the appliance, it is absolutely necessary to learn the chapter "**Safety during use**", along with this chapter.
- If you have any doubts about the combi oven's installation, operation or safety, contact your supplier.
- If the electrical equipment is damaged in any way, arrange repairs immediately – never use a damaged combi oven.
- Do not block the combi oven's vents with objects, and especially do not place cooking utensils, fabrics or other items on the appliance. Make sure that steam freely escapes from the vents at the top of the combi oven.
- Before using, check the combi oven's cooking chamber. Remove all remaining food, cleaning agent residues or other objects, and thoroughly rinse the cooking chamber with the hand shower.
- Be sure not to sprinkle or spray water on the combi oven, and not to place objects filled with water on it.
- Do not place sources of open flame on or near the combi oven.

#### DURING USE OF THE COMBI OVEN

- Do not continue using the combi oven if you have the slightest doubt as to its safe operation or whether it is damaged. Turn it off immediately, unplug the power cable, shut off the water supply, and contact your supplier.
- In the event that while using the combi oven you register an increased noise level exceeding the permitted limit, stop the combi oven and remedy the cause.
- Immediately report all faults to your superior, who must arrange for their repair.
- Do not leave the combi oven unattended while it is turned on, unless explicitly instructed to by the manual.
- Use only your fingers to operate the control panel buttons. Using sharp, pointed or other objects to operate the appliance voids the warranty.
- When working with the combi oven, be aware that cooking containers, cooking inserts and grates can be hot. The temperature of the external glass on the door may reach temperatures higher than 140 °F. In all cases there exists a risk of burns.
- Hot steam is generated while the combi oven is running – when the door is opened, there is a risk of scalding, etc. When opening the door, especially during steam operations, always stand in such a way that you cannot be scalded by the steam escaping from the open door. Open the door only partially and open fully only once the steam has escaped.
- If gastronorm containers are more than three-quarters filled with liquid, greater care must be taken when handling and removing them. When placing containers this full into the appliance, put them only in racks into which you can see. Otherwise, the user may be scalded. Take great care when removing hot cooking containers – whatever their content!
- Be especially careful when working with a combi oven (set of appliances) whose highest rack is 63 in or higher above the ground. Here there is a risk that the gastronorm container may flip over and cause burns.
- Hot areas may form during the cooking process, especially on the cookware, grills and the inner side of the door. Use protective gloves whenever handling hot objects.
- It is forbidden to start the fan without the cover.

- If the combi oven is equipped with a ride-in trolley, then you must always brake the trolley once inside the appliance. When handling a full trolley, the gastronorm container locking mechanism must always be used (GNs are closed).
- When transporting gastronorm containers filled with a liquid, they must be covered with sealing lids. Otherwise, the user may be scalded.
- In the event that the floor is very uneven, ride-in trolleys must not be used for riding into or out of the combi oven. Never leave the trolley handle inside a closed combi oven. The combi oven door could be broken. Do not pull the ride-in trolley without the handle designed for this purpose. Otherwise, this may result in burns.
- When using banquet trolleys, always make sure that the plates are correctly seated on the stands.
- For cleaning the trolleys, always use the automatic cleaning program (if available). Otherwise, use cleaning products designed for semi-automatic cleaning. It is not permitted to use the combi oven without the ride-in trolley for standard work and automatic cleaning!

**AFTER YOU HAVE FINISHED WORKING WITH THE COMBI OVEN**

- Perform cleaning and service only when the combi oven is cold!
- Remove solid pieces of food by taking them out of the cooking chamber – never wash them down the combi oven’s drain.
- Cleaning and descaling agents are to be used only according to the instructions in this manual and in compliance with the instructions for the individual agent.
- After work (e.g. overnight), leave the combi oven’s door ajar.
- When the combi oven is not used for an extended period of time, shut off the water and power supply.

**CLEANING**

- Use extra caution when handling cleaning agents. Contact with cleaning agents and their fumes pose a hazard of burns or irritation to skin, eyes and respiratory organs.
- When handling cleaning agents, wear safety equipment.
- When dosing powdered cleaning agents, be extra cautious that they are not inhaled and do not come into contact with eyes and mucous membranes.

**2.2 PROTECTIVE AIDS**

When operating the combi oven, it is also necessary to wear the right clothes and use personal protection gear. Clothing, shoes and protective gear must comply with national safety requirements for your type of work. Especially do not forget to use these important items:



**When working with the combi oven, we do not recommend wearing:**

- Scarves, neck ties, chains, watches, bracelets, keys, rings or other metal objects, or work with an inappropriate bandage on.
- Electrical components such as heart pacemakers, watches, credit cards, etc., or other items with magnetic recording media.
- Long, loose hair. Secure long hair with an appropriate head covering.

**2.3 PROTECTIVE ELEMENTS OF THE COMBI OVEN**

The combi oven is equipped with safety elements that make it safer to operate. Here is a list of the most important ones:

1. External main switch
2. External covers
3. Protective temperature limiter
4. Control panel
5. Door with magnetic lock
6. Ventilation position of the appliance door
7. Internal wall

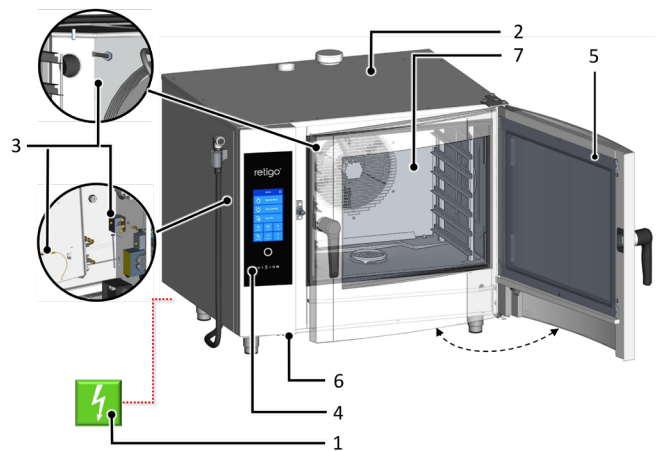

None of the elements below are intended to be removed by the operator. It can be removed for inspection, maintenance or repair only by a person qualified for the task.

**EXTERNAL MAIN SWITCH**

The combi oven is designed for permanent connection to the power grid. Connect and disconnect the power supply using an external main switch. The switch is used for turning the appliance on and off (when starting operation, making repairs, installing, and also in emergencies). The external main switch must be easily accessible at all times!



It is forbidden to tamper with safety circuits, to remove the side covers, or to perform any unauthorised changes, which change the reliability and safety of these circuits.

**EXTERNAL COVERS**

All removable covers are firmly connected to the combi oven, so they can be removed only with tools. Covers prevent unintentionally touching parts carrying electricity. Always check whether the covers are in place.

### PROTECTIVE TEMPERATURE LIMITER

Protective temperature limiters are located in the cooking chamber, boiler and electrical panel. When there is excessive temperature, these elements activate and turn off the appliance.

If a protective limiter fails, an error code displays accompanied by an audible signal.

### CONTROL PANEL

The control panel is located outside the area prone to high temperatures and makes it possible to quickly turn off the appliance using the STOP button. The display also shows malfunctions.

The control panel is securely fixed to the front control panel and prevents unintentionally touching conductive parts. It can be removed only with a tool.

### DOOR WITH MAGNETIC LOCK

The moment the door opens, the heat automatically shuts off and the fan quickly stops to limit the escape of steam from the cooking chamber. To protect against steam scalding, first open the door slightly and wait a while before opening it fully. To close the door, push on the handle (by slamming). If you have a machine with the ride-in trolley (2011, 1221, 2021) close the door and turn the door handle clockwise by 90°.

If the door is not closed properly and the appliance is in the **Start** mode, a "close door" prompt will appear.

### VENTILATION POSITION OF THE APPLIANCE DOOR

To protect against steam scalding, the doors can first be opened slightly. In this position, the doors remain partly locked. Once steam stops coming out of the cooking chamber, the door can be opened completely.

### INTERNAL WALL

It is always located inside the cooking chamber in front of the fan so as to prevent striking against the fan's rotating wheel. The internal wall can only be removed with tools.



**Under no circumstances should you remove any safety or protective element of the combi oven! Do not make any changes to it without the permission of the manufacturer.**

## 2.4 DANGEROUS LOCATIONS AND RESIDUAL HAZARDS

The combi oven is designed so that when properly used in perfect technical condition, it poses no danger to the user or surroundings. Nonetheless, during its operation, situations may arise that could be dangerous if the user is not aware of them. These are called residual hazards — those that remain even after all preventive and protective measures have been considered and implemented. Learn more about these risks and avoid them.

## Dangerous locations, types of hazards and their effects.

### COOKING CHAMBER

While it works, the combi oven creates high-temperature steam in the cooking chamber.



- Burning hazard from hot places throughout the chamber
- Scalding hazard from hot steam produced during the cooking process
- Scalding hazard from hot steam escaping the cooking chamber when the appliance door is opened.

### FAN

In the combi oven's cooking chamber, behind the internal wall, there are one or more circulating fan wheels.



- Hand injury hazard from careless handling in the cooking chamber behind the inside wall when it is not properly installed in place.
- Hand injury hazard from careless handling in the cooking chamber behind the inside wall during cleaning or maintenance.

### DOOR

The inside of the door and especially the internal glass heat up to a high temperature when the combi oven is working. The combi oven also creates hot steam that escapes when the door of the cooking chamber is opened.



- Risk of burns from the inside of the door when opening the door during or after the cooking process.
- Risk of scalding by hot steam and fumes when opening the appliance, and especially when the top of the door is at face level, as it is with sets of two combi ovens.

### UPPER COVER OF APPLIANCE

Never cover the appliance or place on it any objects that may catch fire. Your appliance is not a storage shelf!

Be careful and use safety gloves.



- Risk of burns during the cooking process.
- Fire hazard if the cover is covered or if flammable materials are on the cover during the cooking process.

**GASTRONORM CONTAINERS**

Never handle containers containing hot liquids or hot liquid food above eye level, and always use safety gloves.



- Risk of burns when handled carelessly and when protection aids are not used.

**FLAP AND CHIMNEY**

Do not place any part of the body above these parts and always use protective gear (gloves, safety glasses, etc.).



- Burning hazard from steam escaping during the cooking process

**EXHAUST DISCHARGE**

Do not place any part of the body above these parts and always use safety gear (gloves, safety glasses, etc.).



- Burning hazard from hot flue gases escaping during the cooking process.

**HAND SHOWER**



- Scalding hazard when showering the hot cooking chamber.
- Do not use the hand shower to cool the cooking chamber or for cleaning if its temperature is higher than 194°F.
- Scalding hazard from hot fat and steam when water splashes into hot fat.
- Do not spray water directly into hot fat — this may cause spattering and intense heat creation.

**Residual risks**

Despite the design and technical measures taken, risk analysis shows that certain residual risks remain while the appliance is working. These are due to the technological process during various phases of the appliance's life. This relates primarily to risks resulting from lack of attention by workers and failure to adhere to safety principles.

To further reduce risks and to ensure the effectiveness of safety protection we provide information about residual risks. To remove them, we establish the following technical and organizational measures for implementation by the user. These are intended to overcome the respective hazards.

**Residual risks in the electrical parts of the appliance**



All electrical components (valve motors, etc.) are connected to life-threatening 240 V AC current.

**RISK OF DAMAGING THE ELECTRICAL PARTS OF THE APPLIANCE**

- If the electrical equipment ever becomes damaged, it must be repaired immediately. Damaged equipment must not be used.

**ACCESS TO ELECTRICAL EQUIPMENT UNDER LIVE VOLTAGE**

- When the cover of the electrical equipment is opened, the circuits are still carrying current. If it is not necessary to have the appliance carrying current, unplug it.
- It is forbidden to tamper with safety circuits or to perform any unauthorized changes that alter the reliability and safety of these circuits.

**DANGER OF FAULTY INSTALLATION**

- Wires must be properly marked and the colour designation must conform to the applicable standard.

**Residual risks in the mechanical portion of the appliance**

**RISK OF STABILITY LOSS**

- When handling the appliance, follow the relevant regulations for tying loads and the operating lifting equipment.
- If the appliance's stability must be improved (slippery floor, boat, drilling platform, etc.), it must be anchored. The permitted tilt angle and anchoring conditions need to be agreed to with the manufacturer of the appliance.

**RISKS RESULTING FROM SURFACES, EDGES AND CORNERS**

- With only a few exceptions, all edges have been removed. In other cases, extra caution must be used.

**RISKS FROM MOVING PARTS**

- All covers must be properly mounted and closed; when adjusting the appliance, ensure that the machine cannot be started accidentally.

**RISKS FROM CONTACT WITH VERY HOT OBJECTS:**



**CAUTION STEAM!** When opening the door, especially during steam operations, stand in such a way that you cannot be scalded by the steam escaping from the open door. Open the door only partially and do not open fully until the steam has escaped



**CAUTION HOT!** Hot areas may form during the cooking process, especially on the cookware, grills and the inner side of the door. Use safety gloves whenever handling hot objects.

During the cooking process, do not handle cookware containing liquids or liquid foodstuffs located above eye level. Danger of burns



**USING THE HAND SHOWER!** The hand shower may only be used for cleaning the cooking chamber.

Perform cleaning and service only when the appliance is cold. Do not use the hand shower on the hot appliance! Let the appliance cool below 149°F (65°C)

**RISKS RESULTING FROM DETERGENTS**

When using detergents, avoid direct skin contact with the detergent powder — there is risk of chemical burns. If there is risk of contact, use safety gloves. Use extra caution when dispensing — risk of inhaling detergent powder.

**INSTRUCTIONS ON CLEANING THE APPLIANCE**

Regular daily cleaning, inside and out, will ensure many years of enjoyment from your appliance. Every new appliance comes with a cleaning kit that contains the following:

- For models with automatic cleaning:
  - Retigo Active Cleaner – detergent for automatic washing, five 0,132 lb packages
  - Active Descaler – 0,22 lb pack – for removing limescale deposits from inside the cooking chamber
- For boiler models:
  - STRIP-A-WAY Special – 0.132 gal – for descaling the boiler

On request we will be happy to supply you with detergents for the entire time.

Only use the original cleaning agents Retigo Manual cleaner, PURON K and Retigo Active Cleaning, and STRIP-A-WAY Special.

Do not use aggressive and highly alkaline cleaning agents.

Damage from incorrect cleaning is not covered by the warranty. Carefully read the safety instructions on the product labels of the cleaning agents.

Do not use pressure cleaners or water sprays to clean the cooking chamber or external surface of your appliance.

**HEALTH RISKS FROM A HOT WORK ENVIRONMENT**

Ensure that there is adequate air circulation around the appliance— we recommend using a range hood.

**FIRE RISKS**

Keep the appliance — especially the cooking area — clean, adhere to the prescribed inspection schedule and follow the instructions in the operating manual and comply with generally applicable regulations.

**NOISE RISKS**

When the noise exceeds the permitted threshold, the appliance must be stopped and the cause eliminated.

**RISKS FROM LEAKING HEATING GAS, AN EXPLOSION**

Follow the prescribed inspection plan, follow the instructions in the operating manual, adhere to generally applicable regulations for gas appliances.

**RISK OF SLIPPING, TRIPPING AND FALLING**

Danger of slippery floor near the appliance. Do not place any items near the appliance, which you could trip over. Keep the workplace (including access ways) clean and tidy.

**HAZARDS WHEN WORKING WITH THE APPLIANCE**

Only use the appliance as described in the operating manual, and never bypass safety devices. Eliminate any other type of use.

When adjusting the appliance ensure that the machine cannot be started accidentally, secure the area against access by unauthorized persons. It is forbidden to start the fan without the cover.

**OTHER HAZARDS**

Manually handle only components whose weight is in the permitted range. Unqualified handling of the appliance is not permitted. Pay extra attention to the general regulations for protection against injury and damaging the appliance.

**INFORMATION ON IMPROPER USE**

Appliances are only to be used for the purpose for which they were built and always in accordance with this operating manual. Using the appliance in a way that contradicts this manual is forbidden.

Appliances are designed exclusively for cooking food.

Food can be cooked in the modes hot air, steam, combined mode, stewing, boiling, roasting meat and baking dough, au gratin cooking, grilling, warming, delta T and low-temperature baking.

It is also possible to use the appliance for warming foods, for rising dough, for canning and drying fruit. Any other possible uses are considered unintended use. Retigo accepts no responsibility for resulting damages. The user bears the all risk in this case!

These appliances are not suitable for use in toxic or explosive atmospheres or for thermal preparation in closed containers unless they are designed for this use.

# 3 | OPERATION



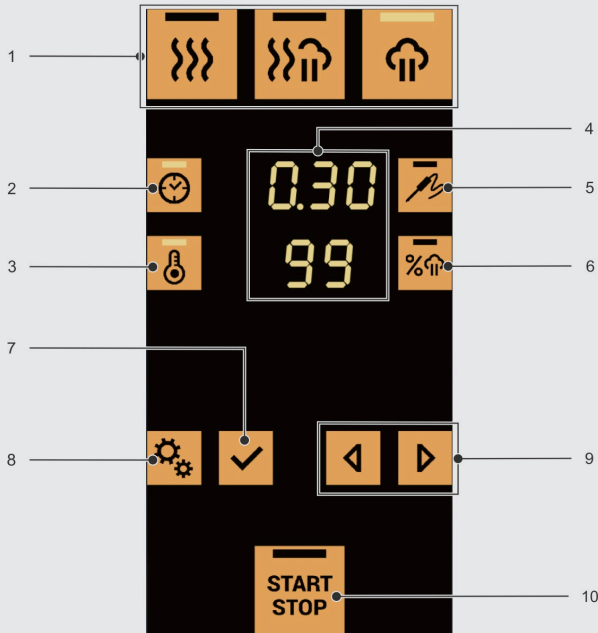















## 3.1 CONTROL PANEL



The combi oven is equipped with a touch control panel. Individual functions are selected by gently "tapping" a button.

1. Cooking mode selection
2. Setting the time
3. Setting the cooking chamber temperature
4. Display with values
5. Setting the temperature probe temperature
6. Setting the humidity level
7. OK (confirmation/enter)
8. Function / back
9. Navigation arrows
10. Start / stop the cooking process

## 3.2 DESCRIPTION OF THE BUTTONS

- 
**HOT AIR MODE**  
 Sets the hot air cooking mode according to presets. The settings can be changed as needed.
- 
**HOT AIR WITH STEAM MODE**  
 Sets the cooking in set humidity mode according to presets. The settings can be changed as needed.
- 
**STEAMING MODE**  
 Sets the steam cooking mode according to presets. The settings can be changed as needed.
- 
**TIME**  
 Serves to set the cooking time.
- 
**TEMPERATURE IN COOKING CHAMBER**  
 Serves to set the cooking temperature.
- 
**TEMPERATURE ON THE TEMPERATURE PROBE**  
 Serves to set the temperature on the temperature probe.
- 
**HUMIDITY LEVEL**  
 Serves to set the humidity in the hot air with steam mode.
- 
**FUNCTION / BACK**  
 Serves to enter other submenus and also serves as a "BACK" button. Other options:
  - 
**FLAP VALVE** (optional accessory)  
 Allows the flap valve to be opened or closed if excess humidity needs to be vented from the cooking chamber.
  - 
**MANUAL HUMIDIFICATION**  
 Enables additional humidity to be added
  - 
**FAN SPEED** (optional accessory)  
 Serves to change the fan speed.
  - PREHEATING**  
 Enables the setting of a preheat mode for the cooking chamber before the cooking process, or alternatively for cooling the cooking chamber when it is too hot.
  - 
**PROGRAMS** (optional accessory)  
 Enables the launching and managing of saved programs.
  - 
**DELAYED START**  
 Serves to set the start time for the cooking process.
  - 
**SETTINGS**  
 Displays the user settings menu.
  - 
**CLEANING**  
 Serves to start washing according to a washing program.
- 
**OK (CONFIRMATION/ENTER)**  
 Serves to confirm the settings or functions and to enter menus and submenus.
- 
**LEFT AND RIGHT NAVIGATION ARROW**  
 Serves to increase or decrease parameter settings and for navigation in the individual submenus.
- 
**START / STOP THE COOKING PROCESS**  
 Serves to start / stop the cooking process.  
 By holding down the button (longer than 3s), the combi oven enters sleep mode, where the entire display goes blank and the button flashes only briefly. To resume activity, simply press the button again.

## 4 | COOKING

Meals may be prepared in the combi oven either by manually setting the parameters or by utilising saved or custom programs (optional accessory).

### 4.1 SETTING COMBI OVEN FUNCTIONS BEFORE STARTING COOKING

Before starting the cooking process, it is possible to set the following combi oven functions:

#### Cooking chamber preheating

##### TURNING ON

|   |        |  |   |
|---|--------|--|---|
| 1 | PRESS  |  |   |
| 2 | SELECT |  | OFF will appear. Symbol  will flash.          |
| 3 | PRESS  |  | Symbol  will be lit. Preheating is activated. |



If Preheat is off, after cooking is launched with the button, first preheating (or cooling) starts in the cooking chamber. The text "Preparing temperature" appears on the display. During preheating, the cooking chamber heats up:

- Hot air, hot air with steam mode:
  - <212°F – for temperature set to +20%
  - >212°F – for temperature set to +36°F
- Steaming mode – directly to set temperature.

When the set temperature is reached, the display shows the message "Insert food" and a sound signals the end of preheating. This sound will repeat every minute until the door is opened. If the user does not open the door to insert the food, the chamber remains at the set temperature.

If 5 minutes after the end of preheating (message display), the user does not insert the food, preheating cancels and the cooking chamber no longer heats.

During manual setting, the user sets preheating in the functions before actually launching cooking.

During cooking according to the program, the preheat setting is used directly from the set program.

You can skip preheating in the "Prepare temperature" phase by pressing the function or the button and launching cooking directly.

##### TURNING OFF

|   |        |  |   |
|---|--------|--|---|
| 1 | PRESS  |  |   |
| 2 | SELECT |  | ON will appear. Symbol  will flash.   |
| 3 | PRESS  |  | The OFF text will disappear. The  symbol will disappear. Preheating is deactivated. |

#### Flap valve (optional accessory)

The flap valve can only be set in modes and .

##### OPENING

|   |       |  |  |
|---|-------|--|--|
| 1 | PRESS |  | OFF will appear. Symbol  will flash.         |
| 2 | PRESS |  | Symbol  will be lit. The flap valve is open. |

##### CLOSING

|   |       |  |  |
|---|-------|--|--|
| 1 | PRESS |  | ON will appear. Symbol  will flash.  |
| 2 | PRESS |  | The OFF text will disappear. The  symbol will disappear. The flap valve is closed. |

#### Delayed start

##### TURNING ON

|   |               |  |  |
|---|---------------|--|--|
| 1 | PRESS         |  |  |
| 2 | SELECT        |  | OFF is shown. Symbol  will flash.  |
| 3 | PRESS         |  | The current time hh.mm and symbol  are flashing.                                   |
| 4 | SET THE VALUE |  | Set the time at which you want the combi oven to start. The set value is flashing. |
| 5 | PRESS         |  | The message "Combi oven will start in hh.mm" where hh.mm is the time that you set. |

##### TURNING OFF



|   |       |  |   |
|---|-------|--|---|
| 1 | PRESS |  | The text "Combi oven will start in hh.mm" will disappear and the countdown will be cancelled. |
|---|-------|--|---|

## 4.2 MANUAL SETTINGS

This option is utilised by more experienced users, who want to have the cooking process parameters set exactly according to their requirements. Set the cooking parameters manually according to your own discretion and experience.



For cooking, the combi oven utilises three basic modes - hot air, steam, and a hot air and steam combination. Each mode has its pre-settings and steps and is used with other technological meal preparations. However, you may enter the cooking process at any phase and modify the time, temperature and humidity so that the result meets your expectations.

The whole cooking process is fully automated and when the exact input conditions are maintained, it is possible to achieve the same quality results every time.

|   |  |
|---|--|
|  | <b>HOT AIR</b><br>Pre-settings:<br>Processing time: 30 min.<br>Cooking chamber temperature: 356°F<br>Humidity: 0%              |
|  | <b>HOT AIR WITH STEAM</b><br>Pre-settings:<br>Processing time: 30 min.<br>Cooking chamber temperature: 320°F<br>Humidity: 50 % |
|  | <b>STEAM COOKING</b><br>Pre-settings:<br>Processing time: 30 min.<br>Cooking chamber temperature: 210°F<br>Humidity: 100 %     |

### Manual cooking process parameter settings

|   |   |
|---|---|
| <b>1 SELECT A COOKING MODE</b>  |     |
| <b>2 SELECT A COOKING PARAMETER</b><br>The current value of the selected parameter will start flashing.<br><br> In <b>HOT AIR</b> mode  and <b>STEAMING</b>  the humidity parameters can't be changed. |     |
| <b>3 ADJUST THE PARAMETER VALUE ACCORDING TO YOUR DISCRETION</b><br>In the same way, modify the other parameters.   |     |
| <b>4 CONFIRM THE SETTING</b>  |    |
| <b>5 START THE COOKING PROCESS</b>  |    |

 You can end the cooking process at any time using the  button. If you do not press the button, the cooking processes will end after the set time and the display will show the text **COOKING DONE**.















### 4.3 PROGRAMS (optional accessory)

The Program mode enables the combi oven to be utilised to the maximum extent possible, with ultimate control comfort ensuring that the final products are repeatedly of the highest quality.















#### Cooking according programs

|   |  |   |
|---|--|---|
| 1 | <b>PRESS</b>   |  |
| 2 | <b>SCROLL TO PROGRAMS</b><br> |  |
| 3 | <b>PRESS</b>   |  |
| 4 | <b>SCROLL TO THE DESIRED PROGRAM</b>   |  |
| 5 | <b>START THE COOKING PROCESS</b>   |  |











#### Cooking according programs with Delayed start

|                   |   |   |
|-------------------|---|---|
| <b>TURNING ON</b> |   |   |
| 1                 | <b>PRESS</b>  |  |
| 2                 | <b>SELECT</b><br> OFF is shown. Symbol  will flash. |  |
| 3                 | <b>PRESS</b><br>The current time hh.mm and symbol  are flashing.   |  |
| 4                 | <b>SET THE VALUE</b><br>Set the time at which you want the combi oven to start. The set value is flashing.  |  |
| 5                 | <b>PRESS</b><br>The message "Combi oven will start in hh.mm" where hh.mm is the time that you set.  |  |
| 6                 | <b>PRESS</b><br>Icon  will appear  |  |
| 7                 | <b>CHOOSE THE PROGRAM</b>   |  |
| 8                 | <b>PRESS</b><br>There will appear current time on the first display, choosed program on the second display and the message "Combi oven will start in hh.mm" where hh.mm is the time of start on the third display.        |  |





















## Adding a program step

|   |  |  |
|---|--|--|
| <b>1</b>  | <b>PRESS</b>   |     |
| <b>2</b>  | <b>SELECT PROGRAMS</b><br>  |     |
| <b>3</b>  | <b>PRESS</b>   |     |
| <b>4</b>  | <b>SELECT THE DESIRED PROGRAM</b>  |     |
| <b>5</b>  | <b>ENTER THE PROGRAM</b><br>Press and hold the button for more than 2 seconds. The program number appears with the number of program steps (e.g. 13 - 1/2, where 13 is the program number, 1 is the order of the currently displayed step, and 2 is the total steps in the program). |     |
|  | If you want to add a new step to a program that has more than one step, after choosing the program, use the navigation arrow to select the step after which you want to add a new step. Otherwise, the new step will be added as Step 1.   |    |
| <b>6</b>  | <b>OPEN THE PROGRAM ACTIVITY MENU</b><br>ADD will appear.  |   |
| <b>7</b>  | <b>CONFIRM THE SELECTION</b><br>The new step number will appear and all the mode buttons will start flashing.  |   |
| <b>8</b>  | <b>SELECT A COOKING MODE</b>   |  |
| <b>9</b>  | <b>SELECT A COOKING PARAMETER</b><br>The current value of the selected parameter will start flashing.  |  |
| <b>10</b>   | <b>EDIT THE PARAMETER VALUE</b><br>In the same way, modify the other parameters.   |  |
| <b>11</b>   | <b>CONFIRM THE SETTING</b>   |   |
| <b>12</b>   | <b>START THE COOKING PROCESS</b>   |   |

## Editing parameters of a saved program

|   |   |
|---|---|
| <b>1 PRESS</b>  |    |
| <b>2 SELECT PROGRAMS</b><br> |    |
| <b>3 PRESS</b>  |    |
| <b>4 ENTER THE PROGRAM</b><br>Press the button longer than 3s   |    |
| <b>5 CHANGE A COOKING MODE</b>  |   |
| <b>6 SELECT A COOKING PARAMETER</b><br>The current value of the selected parameter will start flashing.       |   |
| <b>7 EDIT THE PARAMETER VALUE</b><br>In the same way, modify the other parameters.                            |  |
| <b>8 CONFIRM THE SETTING</b>  |  |
| <b>9 START THE COOKING PROCESS</b>  |  |

## Creating a new program





|           |  |  |
|-----------|--|--|
| <b>1</b>  | <b>PRESS</b>   |     |
| <b>2</b>  | <b>SELECT PROGRAMS</b><br>  |     |
| <b>3</b>  | <b>PRESS</b>   |     |
| <b>4</b>  | <b>SCROLL TO AN AVAILABLE PROGRAM POSITION (E.G. NO.56)</b>  |     |
| <b>5</b>  | <b>ENTER THE PROGRAM</b><br>Press the button longer than 3s  |     |
| <b>6</b>  | <b>OPEN THE PROGRAM ACTIVITY MENU</b><br>ADD will appear.  |     |
| <b>7</b>  | <b>CONFIRM THE SELECTION</b><br>The program number, number of steps will appear and all the mode buttons will start flashing.  |    |
| <b>8</b>  | <b>SELECT A COOKING MODE</b>   |  |
| <b>9</b>  | <b>SELECT A COOKING PARAMETER</b><br>The current value of the selected parameter will start flashing.  |  |
| <b>10</b> | <b>ADJUST THE PARAMETER VALUE ACCORDING TO YOUR DISCRETION</b><br>In the same way, modify the other parameters.  |   |
| <b>11</b> | <b>CONFIRM THE MODIFICATIONS</b><br>The ADD menu will appear again.  |   |
| 11.1      | <b>OPTION: ADD ANOTHER STEP</b><br> Repeat the procedure of steps 6-11  |  |
| 11.2      | <b>OPTION: NAMING A PROGRAM</b><br> Return to the program activity menu (point 6) and select the <b>NAME</b> menu |   |
|           | Enter the menu.<br>A dot will appear.  |   |
|           | Find the first letter of the program name<br>(e.g. N)  |   |
|           | Confirm the letter<br>A decimal point will start flashing at the current letter.   |   |
|           | Press again to return to the name, press again    |  |
|           | Enter the remaining letters of the program name in the same fashion and confirm  |   |
|           | Return to the program  |   |

|   |   |   |
|---|---|---|
| 11.3  | OPTION: OTHER COOKING PARAMETER SETTINGS  |   |
|    | <b>PREHEATING</b>   |   |
|    | Return to the program activity menu (point 6) and select the <b>PREHEATING</b> menu.  |    |
|   | Activate the <b>PREHEAT</b> function (only possible at the first program step). More on Preheat in chapter 4.1. <b>ON</b> will appear.                      |    |
|   | Return to the program.  |    |
|    | <b>FLAP VALVE</b> (optional accessory)  |   |
|   | Return to the program activity menu (point 6) and select the <b>FLAP VALVE</b> menu.  |    |
|   | Activate the <b>FLAP VALVE</b> function. <b>ON</b> will appear.   |    |
|   | Return to the program.  |    |
|   | <b>FAN SPEED</b> (optional accessory)   |   |
|   | Return to the program activity menu (point 6) and select the <b>SPEED</b> menu. The default speed is 100%. In Steam Cooking mode, the default speed is 50%. |  |
|   | Change the speed as required. The speed value changes cyclically each time the button is pressed.   |  |
|   | Return to the program.  |  |
|  | <b>SOUND SIGNAL AT THE END OF A STEP</b>  |   |
|   | Return to the program activity menu (point 6) and select the <b>BEEP</b> menu.  |  |
|   | Activate the sound signal function. <b>ON</b> will appear.  |  |
|   | Return to the program.  |  |
| 12  | <b>START THE COOKING PROCESS</b>  |  |
| 13  | <b>OR RETURN TO THE ALL PROGRAMS MENU</b>   |  |

## Deleting a program step

|    |   |   |
|----|---|---|
| 1  | <b>PRESS</b>  |    |
| 2  | <b>SELECT PROGRAMS</b><br> |    |
| 3  | <b>PRESS</b>  |    |
| 4  | <b>SELECT A PROGRAM THAT YOU WISH TO EDIT</b>   |    |
| 5  | <b>ENTER THE PROGRAM</b><br>Press the button longer than 3s   |    |
| 6  | <b>SELECT THE STEP THAT YOU WISH TO DELETE (E.G. 2/2)</b>   |    |
| 7  | <b>OPEN THE PROGRAM ACTIVITY MENU</b><br>Activate the program activity menu<br>ADD will appear.             |   |
| 8  | <b>SELECT DELETE</b>  |  |
| 9  | <b>PRESS</b><br>The step is deleted.  |  |
| 10 | <b>RETURN TO THE ALL PROGRAMS MENU</b>  |  |
| 11 | <b>RETURN TO THE MAIN MENU</b>  |  |

## Deleting a program

|    |   |   |
|----|---|---|
| 1  | <b>PRESS</b>  |    |
| 2  | <b>SELECT PROGRAMS</b><br>                     |    |
| 3  | <b>PRESS</b>  |    |
| 4  | <b>SELECT A PROGRAM THAT YOU WISH TO DELETE</b>   |    |
| 5  | <b>ENTER THE PROGRAM</b><br>Press the button longer than 3s   |    |
| 6  | <b>ACTIVATE THE PROGRAM ACTIVITY MENU</b><br>ADD will appear.   |    |
| 7  | <b>SELECT DELETE</b>  |   |
| 8  | <b>PRESS</b><br>The step is deleted.  |  |
| 9  | <b>IF THE PROGRAM HAS MULTIPLE STEPS, REPEAT PROCEDURE 6-8</b><br>When all the steps are deleted, the entire program is deleted |   |
| 10 | <b>RETURN TO THE ALL PROGRAMS MENU</b>  |  |
| 11 | <b>RETURN TO THE MAIN MENU</b>  |  |









# 5 | SETTINGS

The SETTINGS menu is used to perform user settings on your combi oven. In the menu you will find:

|                    |   |
|--------------------|---|
| <b>1. TIME</b>     | Serves to set the current time.   |
| <b>2. SOUNDS</b>   | Set sounds that accompany various combi oven activities.  |
| <b>3. VOLUME</b>   | Serves to set the volume of sounds.   |
| <b>6. USB</b>      | Serves to copy programs, sounds, languages, HACCP, function logs to/from a USB disk.  |
| <b>7. OPTIONS</b>  | Serves to set functions as Permanent light, ACM, Standby after cleaning, Shower lock, Program lock, Preheating automatically. |
| <b>8. LANGUAGE</b> | Serves to set the language for all menus.   |



## 5.1 USING THE SETTINGS MENU

### Enter the Settings

|   |   |
|---|---|
| <b>1 PRESS</b>  |    |
| <b>2 SELECT A SETTING</b><br>                                    |    |
| <b>ENTER THE SETTINGS WITHOUT PIN CODE</b>  |   |
| <b>2.1 PRESS 2X</b><br>To set items: 1. Time, 2. Sounds, 3. Volume, 5. Boiler, 6. USB, 7. Options – 7.1 Continuous lighting, 7.6 Automatic preheat. |    |
| <b>ENTER THE SETTINGS WITH PIN CODE 1001</b>  |   |
| <b>2.2 PRESS 1X AND SET THE PIN CODE 1001</b><br>To set 7. Options - 7.2 ACM, 7.3 Standby after cleaning, 7.4 Shower lock, 7.5 Program lock         |    |
| <b>2.2.1 PIN setting</b><br>To change value of number press   |   |
| <b>2.2.2</b> To change number position press Time or Temperature core probe button  |   |
| <b>2.2.3</b> Confirm the PIN CODE   |    |











## Navigation in the Settings menu





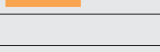



|  |   |
|--|---|
| <b>1</b> NAVIGATION BETWEEN THE INDIVIDUAL MENU ITEMS AND SUBMENUS / ITEM VALUE SETTINGS |  |
| <b>2</b> SELECTION OF ITEM 1 – 8 / CONFIRM SETTINGS                                      |  |
| <b>3</b> EXIT FROM ANY MENU OR SUBMENU / CANCEL A SETTING                                |  |

## 5.2 INDIVIDUAL ITEMS IN THE SETTINGS MENU









### 1. Time

|  |   |
|--|---|
| <b>1</b> ENTER THE SETTINGS MENU WITHOUT PIN CODE<br>Enter the setting menu without PIN code is described in chapter 5.1 |  |
| <b>2</b> SELECT ITEM 1. TIME   |  |
| <b>1.1 HOURS</b>   |   |
| Select item 1.1 Hours.<br>The current value will start flashing.   |  |
| Set the desired hour.  |  |
| Confirm the setting.   |  |
| <b>1.2 MINUTES</b>   |   |
| Select 1.2 Minutes.<br>The current value will start flashing   |  |
| Set the desired minutes.   |  |
| Confirm the setting.   |  |
| Return to the <b>SETTINGS</b> menu.  |  |

## 2. Sounds

|          |  |   |
|----------|--|---|
| <b>1</b> | <b>ENTER THE SETTINGS MENU WITHOUT PIN CODE</b><br>Enter the setting menu without PIN code is described in chapter 5.1 |    |
| <b>2</b> | <b>SELECT ITEM 2. SOUNDS</b>   |   |
| <b>3</b> | <b>SELECT OF THE FOLLOWING ITEMS</b>   |    |
|          | <b>2.1 KEYBOARD</b>  |   |
|          | <b>2.2 END OF COOKING</b>  |   |
|          | <b>2.3 END OF STEP</b>   |   |
|          | <b>2.4 PREHEATING</b>  |   |
|          | <b>2.5 ERRORS</b>  |   |
| <b>4</b> | <b>PRESS</b><br>The current setting will start flashing.   |    |
| <b>5</b> | <b>SET THE REQUIRED SOUND</b>  |   |
| <b>6</b> | <b>CONFIRM THE SETTING</b>   |    |
| <b>7</b> | <b>RETURN BACK TO THE MENU SETTINGS</b>  |    |

## 3. Volume

|          |  |   |
|----------|--|---|
| <b>1</b> | <b>ENTER THE SETTINGS MENU WITHOUT PIN CODE</b><br>Enter the setting menu without PIN code is described in chapter 5.1 |    |
| <b>2</b> | <b>SELECT ITEM 3. VOLUME</b>   |   |
| <b>3</b> | <b>SELECT OF THE FOLLOWING ITEMS</b>   |    |
|          | <b>3.1 KEYBOARD</b>  |   |
|          | <b>3.2 END OF COOKING</b>  |   |
|          | <b>3.3 END OF STEP</b>   |   |
|          | <b>3.4 PREHEATING</b>  |   |
|          | <b>3.5 ERRORS</b>  |   |
| <b>4</b> | <b>PRESS</b><br>The current value will start flashing.   |    |
| <b>5</b> | <b>SET THE DESIRED VOLUME</b>  |   |
| <b>6</b> | <b>CONFIRM THE SETTING</b>   |    |
| <b>7</b> | <b>RETURN BACK TO THE SETTINGS MENU</b>  |    |

## 6. USB

### INSERT THE USB DISK INTO THE COMBI OVEN

#### ENTER THE SETTINGS MENU WITHOUT PIN CODE

Enter the Setting menu without PIN code is described in chapter 5.1



#### SELECT ITEM 6. USB



### FROM COMBI OVEN TO USB

#### 1 SELECT ITEM 6. 1 COMBI OVEN TO USB



#### 2 SELECT OF THE FOLLOWING ITEMS DEPENDING ON WHICH DATA YOU WISH TO COPY



##### 6.1.1 PROGRAMS

##### 6.1.2 HACCP

##### 6.1.3 LOGS

##### 6.1.4 ERRORS

##### 6.1.5 SOUNDS

#### 3 PRESS

Data will start to be exported from the combi oven to the USB disk. The upper display shows moving dots that signal copying progress.



If the data is copied properly:

**donE**

If an error occurs during copying:

**Err**

If there are no files that can be copied:

**nonE**

#### 4 RETURN BACK TO THE SETTINGS MENU



### FROM USB TO COMBI OVEN

#### 1 SELECT ITEM 6. 2 USB TO COMBI OVEN



#### 2 SELECT OF THE FOLLOWING ITEMS DEPENDING ON WHICH DATA YOU WISH TO COPY



##### 6.2.1 PROGRAMS

##### 6.2.2 SOUNDS

##### 6.2.3 LANGUAGE

#### 3 PRESS

Data will start to be exported from the USB to the combi oven. The upper display shows moving dots that signal copying progress.



The information on copying results is the same as in point 3 in the section From combi oven to USB (see above).

#### 4 RETURN BACK TO THE SETTINGS MENU



The USB disk must be formatted in the **FAT or FAT32** file system format. The names of the files and directories are not case sensitive.



When copying **programs from a USB disk to a combi oven**, the programs on the USB disk must be contained in a file **with the suffix \*.or2** directly in the root directory.

When copying **sounds from the USB disk to the combi oven**, the sound files **\*.wav** must be located directly in the root directory or in the directory **sound**.

When copying **languages from the USB disk to the combi oven**, the language files **\*.lng** must be located directly in the root directory or in the directory **language**.









## 7. Options

Explanation of individual items in the OPTIONS selection.









|                                      |   |
|--------------------------------------|---|
| <b>7.1. PERMANENT LIGHT</b>          | The lights will be continuously on in the cooking chamber. If the function is off, the lights will go on only when the door is open and when the appliance is being operated.   |
| <b>7.2. ACM</b>                      | ACM (Automatic capacity management) – this function ensures that the combi oven will identify the amount of food that is inserted and will extend the cooking time accordingly to achieve the required temperature in the cooking chamber.  |
| <b>7.3. STANDBY AFTER CLEANING</b>   | Allows the combi oven to turn off after cleaning is done. After cleaning, the combi oven shuts off for after about 3 minutes.   |
| <b>7.4. SHOWER LOCK</b>              | The shower is an optional accessory and is not in the appliance's basic configuration. The shower must be activated in this option if the appliance has one.  |
| <b>7.5. PROGRAM LOCK</b>             | Programs are optional and are not in the appliance's basic configuration. Programs must be activated in this option if the appliance has them.  |
| <b>7.6. PREHEATING AUTOMATICALLY</b> | <p>This function applies only to cooking with manual settings. If it is set to Yes, preheating automatically stops after the cooking process is launched. More on Preheat in chapter 4.1.</p> <p>During programmed cooking, preheating starts or doesn't start, as set in the program.</p> <p>Preheat can be skipped by pressing the  function button or OK .</p> |

## Setting items in OPTIONS

### OPTIONS WITHOUT PIN CODE

|  |   |
|--|---|
| <b>1 ENTER THE SETTINGS MENU WITHOUT PIN CODE</b><br>Enter the Setting menu without PIN code is described in chapter 5.1 |    |
| <b>2 SELECT ITEM 7. OPTIONS</b>  |   |
| <b>3 SELECT OF THE FOLLOWING ITEMS</b><br>All the items listed below are set as inactive at the factory.                 |   |
| <b>7.1 PERMANENT LIGHT</b>   |   |
| <b>7.6 AUTOMATIC PREHEAT</b>   |   |
| <b>4 THE CURRENT SETTING WILL START FLASHING.</b><br>Choose Yes or No  |   |
| <b>5 RETURN BACK TO THE SETTINGS MENU</b>  |    |

### OPTIONS WITH PIN CODE 1001

|   |   |
|---|---|
| <b>1 ENTER THE SETTINGS MENU WITHOUT PIN CODE 1001</b><br>Enter the Setting menu with PIN code is described in chapter 5.1                        |    |
| <b>2 SELECT ITEM 7. OPTIONS</b>   |   |
| <b>3 SELECT OF THE FOLLOWING ITEMS</b><br>The items 7.2 ACM and 7.3 Sleep After Cleaning are set as active at the factory. The rest are inactive. |   |
| <b>7.2 ACM</b>  |   |
| <b>7.3 STANDBY AFTER CLEANING</b>   |   |
| <b>7.4 SHOWER LOCK</b>  |   |
| <b>7.5 PROGRAMS LOCK</b>  |   |
| <b>4 THE CURRENT SETTING WILL START FLASHING.</b><br>Choose Yes or No   |   |
| <b>5 RETURN BACK TO THE SETTINGS MENU</b>   |    |

## 8. Language

**1 ENTER THE SETTINGS MENU WITHOUT PIN CODE 1001**  
Enter the Setting menu with PIN code is described in chapter 5.1



**2 SELECT ITEM 10. LANGUAGE**  
The current language will start flashing.



**3 SELECT THE DESIRED LANGUAGE**



8.01 CS - CZECH

8.02 DE - GERMAN

8.03 EN - ENGLISH

8.04 ES - SPANISH

8.05 ET - ESTONIAN

8.06 FI - FINNISH

8.07 FR - FRENCH

8.08 HR - CROATIAN

8.09 LT - LITHUANIAN

8.10 NL - DUTCH

8.11 NO - NORWEGIAN

8.12 PL - POLISH

8.13 RU - RUSSIAN

8.14 SL - SLOVENIAN

8.15 SR - SERBIAN

**4 CONFIRM THE SETTING**



**5 RETURN BACK TO THE MENU SETTINGS**



# 06 | MAINTENANCE

## GENERAL INSTRUCTIONS

For the entire period of operation, the appliance must undergo regular inspections, tests and updates for operating this type of appliance in accordance with applicable regulations in the country of use.

The appliance must be kept clean, and any remains of old fat and food must be removed. Only regular maintenance and adherence to all instructions can ensure that the appliance will last a long time, operate well, and prepare high-quality foods.

Once work is over, close the appliance's water feed! Leave it open only if it is connected to a water treatment device requiring regular regeneration. When the supply is closed, regeneration would not take place, and the water treatment device would not work properly.

The warranty does not apply to damage caused by failure to follow these instructions or caused by inadequate cleaning!

To clean the appliance, the following are not to be used:

- a high-pressure cleaning device
- coarse or sand-based cleaning agents
- objects for mechanical surface cleaning (wire brushes, scrapers, knives)

The warranty does not cover damage arising caused by detergents other than those recommended by the manufacturer, or by use of detergents recommended by the manufacturer in contradiction to the manufacturer's recommendations!

If the appliance is defective or does not behave normally, stop using it, unplug it, and contact an authorized service company.



Before using or maintaining the appliance, become thoroughly familiar with all instructions, prohibitions and recommendations in the chapter on safety INSTRUCTIONS (see "Basic information", chapter 2 "Safety instructions").

Do not spray water on the door glass and lights if the internal temperature is above 149°F — this may break the glass!

| MAINTENANCE OVERVIEW |                             |   |
|----------------------|-----------------------------|---|
| PROGRAM              | DESCRIPTION                 | DESCRIPTION OF TASK   |
| Daily                | Cooking chamber             | Cleaning with the automatic program and ACTIVE CLEANER                                |
|                      | Door seal                   | Manual cleaning using a cloth, detergent and water                                    |
|                      | Exterior                    | Manual cleaning using a soft rag and substance for treating stainless steel and glass |
| Weekly               | Cooking chamber             | Cleaning with the automatic program and VISION DESCALER                               |
|                      | Space behind the inner wall | Hand cleaning using Manual Cleaner or PURON K and the following RINSE program         |
|                      | Air filter                  | Hand cleaning with detergent or in a dishwasher                                       |
|                      | Cleaning door and glass     | Hand cleaning using cloths and appropriate cleaning agents                            |
| Every six months*    | Boiler                      | Descaling with the automatic program and STRIP-A-WAY descaler                         |
| Yearly               | Entire appliance            | Inspection by an authorized company   |

\* applies only to appliances with a boiler

## 6.1 DAILY MAINTENANCE

The appliance must be cleaned daily with the manufacturer's recommended cleaning agents. If not cleaned adequately, the appliance or its parts may become damaged.

### WASHING THE COOKING CHAMBER

For everyday appliance cleaning, use one of the programs in the Cleaning function, which you will find in the appliance's menu.



The manual for using automatic cleaning can be found in chapter 7. Automatic cleaning.

When cleaning, use only cleaning agents recommended by the manufacturer — especially Active Cleaner and Vision Descaler.

After the cleaning program is done, check whether cleaning was adequate. If not, repeat the wash. If residue of a cleaning agent sticks to the surface of the cooking chamber or its accessories, rinse it with the hand shower or start the Rinse program. If this isn't done, the stainless-steel surface of the cooking chamber can distort and discolour when the appliance is used at high temperatures. The warranty does not cover damage caused in this way!

After the cooking chamber has been cleaned, open the door and leave it half open to fully dry out the chamber.



When working with detergents always take great care to follow the manual and recommendations of the detergent manufacturer. This will prevent a health risk!

When cleaning the appliance, always use safety gear and prescribed work clothing (gloves, goggles, mask)!

When using automatic cleaning programs on appliances with a loading trolley, it is absolutely necessary to move the trolley into the appliance before starting the cleaning program!

Automatic cleaning programs are not for cleaning cooking containers or sheets!

When the appliance is being cleaned with a detergent, its temperature must never exceed 158°F. At higher temperatures, the detergent may bake onto the surface of the cooking chamber and form stains resembling rust or do other damage to the appliance. The warranty does not apply to this type of damage!

**CLEANING THE DOOR SEAL**

After the cooking chamber has been cleaned, wipe around the door seal with a soft cloth soaked in detergent. Then wipe around the seal with a cloth soaked in clean water, and then dry it with a dry cloth. After cleaning is over, leave the appliance's door half open, so that the cooking chamber and door seal can properly dry off.



**CLEANING THE EXTERNAL PARTS**

Clean the outside of the appliance with a soft cloth and a detergent intended for cleaning and treating stainless steel and glass.

**6.2 WEEKLY MAINTENANCE**

**DESCALING THE COOKING CHAMBER**

If a crust of limescale appears on the surface areas of the cooking chamber, descale the cooking chamber with the "Cooking chamber descaling" program, and use the Vision Descaler product for this.



If the cooking chamber becomes considerably scaled, find out the current composition of the water, the correct operation of the water treatment device, if there is such an appliance on the front end. Damage caused by water that does not meet the manufacturer's requirements, or inadequate maintenance, is not covered by the warranty!

**INSPECTING AND CLEANING THE SPACE BEHIND THE INNER WALL**

For weekly maintenance, proceed as with daily maintenance (see chapter 7.1) and thoroughly check the space behind the inner wall.

1. Clean out the left and right racks (does not apply to appliances with a loading system).

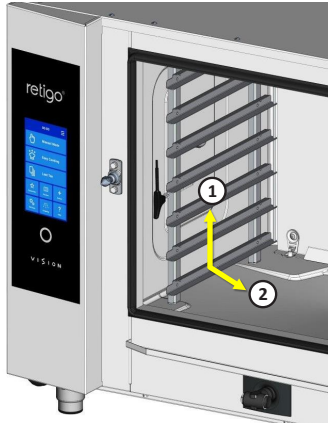

2. Release the locks fastening the wall in front of the fan. A screwdriver or coin can be used to release them.

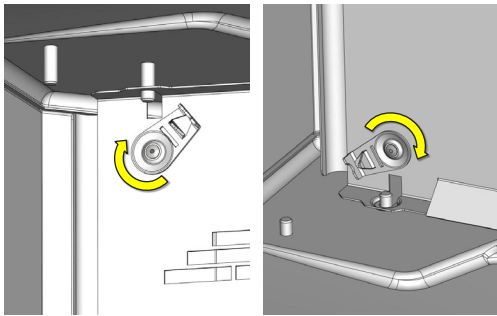

Open the inner wall by pulling on the left side.

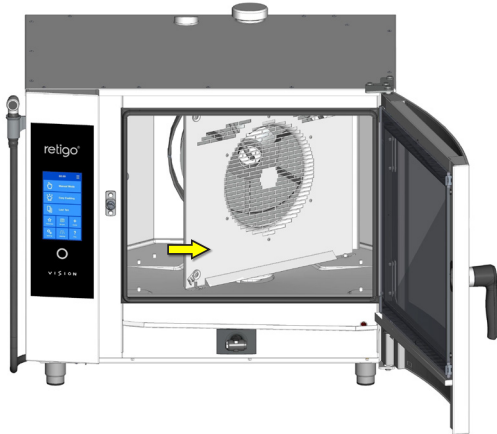

If parts of the space are soiled or calcified, close the inner wall, secure it with the lock, and choose the right cleaning program for the type and level of soiling. After the cleaning program is done, check whether cleaning was adequate (proceed according to points 2 to 3). If everything is not clean enough, repeat the process. If cleaning was adequate, close the inner wall (in front of the fan), use the integrated lock to secure it against opening by itself, and put both racks back (does not apply to appliances with a loading system).

3. After cleaning is over, leave the appliance doors open so that the cooking chamber can fully dry out. This also makes the door seals last longer.

### HAND CLEANING OF THE SPACE BEHIND THE INNER WALL



In rare cases, even repeated automatic cleaning and descaling may be ineffective against tough grime behind the inner wall. In such cases, a cleaning agent (Manual Cleaner) or descaler (Puron K) must be applied by hand as follows:

1. Open the inner wall in the manner described earlier in this chapter.
2. Spray Manual Cleaner or Puron K (for descaling) onto the entire surface of the inside wall – fan, water sprayer (tube in the middle of the fan into which the injection leads) and the heating element – and let it work for 15 minutes.
3. Thoroughly rinse the cooking chamber by starting the automatic cleaning program Rinse.
4. After the cleaning program is done, check whether cleaning was adequate. If everything is not clean enough, repeat the process. If cleaning was adequate, close the inner wall (in front of the fan), use the integrated lock to secure it against opening it by itself, and put both racks back (does not apply to appliances with a loading system).
5. After cleaning is over, leave the appliance doors open so that the cooking chamber can fully dry out. This also makes the door seals last longer.

### CLEANING THE AIR FILTER

Once a month, check and clean the air filter, which is on the bottom left side of the appliance.

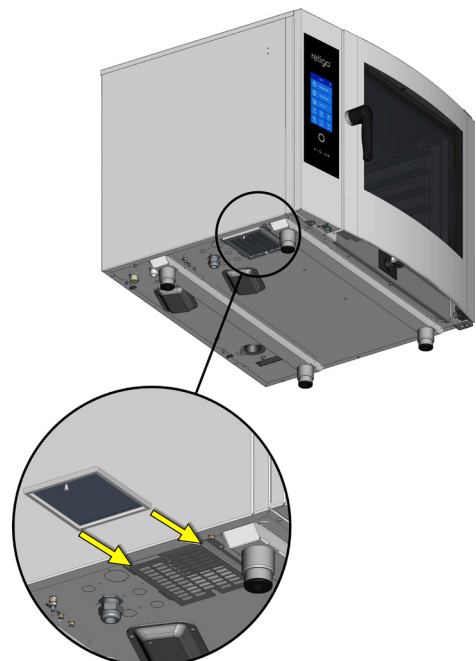

**Remove the filter toward the closer side of the appliance and thoroughly clean it with detergent or in a dishwasher. After cleaning, let it thoroughly dry.**



**If the air filter gets clogged, the appliance's electronic components may overheat and the appliance's function may be limited.**



# 7 | AUTOMATIC CLEANING

The ORANGE VISION combi oven is equipped with an automatic cleaning system, which ensures that the combi oven will always be perfectly hygienically clean.

Regular use of this automatic cleaning system saves you time and significantly prolongs the life of the appliance.

Thanks to this system, the only cleaning tasks on this appliance are:

- choosing the right cleaning program for the level of soiling
- starting the cleaning program and adding detergent.

## 7.1 BASIC INFORMATION AND WARNINGS



For automatic cleaning, you must use the Active Cleaner detergent, which is packed in 60 g plastic bags. It is delivered in small buckets containing 50 packs.

The detergent's package protects it from moisture damage, nevertheless it should be stored in places where no water or excess humidity is present. Always use the detergent immediately after opening the package. Never leave it open, and most importantly, do not leave it in damp places or unsupervised.



### Important information:

- If a detergent other than original Active Cleaner is used (Retigo Manual Cleaner, Vision Descaler), Retigo takes no responsibility for any damage, and the warranty does not apply to damage caused in this way.
- Keep the detergent out of the reach of children.
- When handling the detergent, follow all rules for working safely with chemical substances, and especially use safety gear (primarily gloves and protective glasses).
- Follow the instructions on the detergent package.
- The detergent must never come into direct contact with the skin, eyes or mouth.
- Never open the appliance's door when the cleaning program is running – this can cause a chemical exposure hazard.
- Also remove gastronorm pans from the combi oven before cleaning it.
- Follow all instructions shown on the appliance's display.
- After using the detergent, do not leave the detergent package in the cooking chamber.
- Never spill the detergent on the appliance's hot surface – this can irreversibly damage the stainless steel surface. The warranty does not apply to appliances damaged in this way.
- If cleaning is inadequate, fat build-up in the appliance's cooking chamber may ignite during ordinary operation.

The combi oven has six cleaning programs. Which program to use depends on the level of soiling in the cooking chamber

| PROGRAM | NAME                         | DETERGENT               | DURATION* |
|---------|------------------------------|-------------------------|-----------|
| 1.      | Expres cleaning              | Active Cleaner 1 pack   | 00:29:01  |
| 2.      | Basic cleaning               | Active Cleaner 1 pack   | 00:49:21  |
| 3.      | Medium cleaning              | Active Cleaner 1 pack   | 01:15:06  |
| 4.      | Extra cleaning               | Active Cleaner 2 packs  | 01:49:00  |
| 5.      | Water rinse                  | No                      | 00:16:50  |
| 6.      | Descaling of cooking chamber | Vision Descaler 1 packs | 01:15:06  |

\* The cleaning times are for reference only and may differ slightly depending on the size of the appliance.

Depending on the size of the combi oven and the cleaning program chosen, it is also necessary to select the right amount of detergent. The amount of cleaning agent needed depends on the degree and character of the appliance's grime.







| PROGRAM |                             | FULL SIZE COMBI OVENS       |      |      |      |
|---------|-----------------------------|-----------------------------|------|------|------|
|         |                             | AMOUNT OF DETERGENT (units) |      |      |      |
|         |                             | 621                         | 1021 | 1221 | 2021 |
|         | Water rinsig*               | 0                           | 0    | 0    | 0    |
|         | Express cleaning            | 1                           | 1    | 2    | 3    |
|         | Basic cleaning              | 2                           | 2    | 2    | 4    |
|         | Medium cleaning             | 2                           | 2    | 2    | 4    |
|         | Extra strong cleaning       | 2                           | 3    | 3    | 5    |
|         | Cooking chamber descaling** | 1                           | 1    | 2    | 3    |

| PROGRAM |                             | HALF SIZE COMBI OVENS       |     |      |      |
|---------|-----------------------------|-----------------------------|-----|------|------|
|         |                             | AMOUNT OF DETERGENT (units) |     |      |      |
|         |                             | 623                         | 611 | 1011 | 2011 |
|         | Water rinsig*               | 0                           | 0   | 0    | 0    |
|         | Express cleaning            | 1                           | 1   | 1    | 2    |
|         | Basic cleaning              | 1                           | 1   | 1    | 2    |
|         | Medium cleaning             | 1                           | 1   | 1    | 2    |
|         | Extra strong cleaning       | 1                           | 2   | 2    | 3    |
|         | Cooking chamber descaling** | 1                           | 1   | 1    | 2    |

\* Water rinsing is done without detergent.

\*\* Vision Descaler is used for descaling.

## 7.2 STARTING THE CLEANING

|  |  |
|--|--|
| <b>1 PRESS</b>   |   |
| <b>2 CHOOSE CLEANING</b>                               |   |
| <b>3 PRESS</b>   |   |
| <b>4 CHOOSE PROPER PROGRAM</b>                         |   |
| <b>5 PRESS</b><br>It appears <b>PRESS START</b>        |   |
| <b>5 TO START THE CLEANING PRESS</b>                   |   |
| <b>TO RETURN TO THE MAIN MENU PRESS</b>                |  |
| <b>6 COMBI OVEN WILL ASK YOU TO INSERT A DETERGENT</b> |  |

When Start is pressed, the combi oven automatically checks that the temperature inside the cooking chamber is not too high. If the temperature is above 176°F, the automatic process for cooling the cooking chamber will begin.

If the temperature does not exceed 176°F or cooking chamber cooling has finished, your appliance will prompt you to add detergent.



**When handling the detergent, follow all rules for working with chemical substances!**

### ADDING DETERGENT



- Cut open the detergent bag at the place indicated
- Pour the entire contents of the package on to the drain lid at the bottom of the cooking chamber. Most of the powder will fall through into the drain hole.
- close the combi oven door

The selected program will start automatically, and the screen will keep you informed about the current status of the program and the cleaning time left.

After the cleaning program ends, a signal sound is made and a message appears.

### STOPPING THE CLEANING PROGRAM PREMATURELY

You can interrupt the cleaning process during the main step with the **STOP** button shown on the screen. If detergent has already been inserted, the combi oven switches to Rinse with Water mode, which lasts about 17 min. Then the washing process completely stops. If detergent hasn't been inserted yet, the cleaning process immediately stops (without going to Rinse with Water).



- When the cleaning process has finished, check the cooking chamber. Remove any remaining detergent by thoroughly rinsing with the hand shower or cleaning with water. If this isn't done, the stainless-steel surface of the cooking chamber can distort and discolour when the appliance is used at high temperatures. The warranty does not cover damage caused in this way!
- Do not disconnect the electricity to the combi oven during cleaning. Bits of detergent may remain in the cooking chamber.
- Do not wash the combi oven using equipment that works with high water pressure.
- If the combi oven won't be used again after cleaning, we recommend leaving the door ajar, for example overnight
- Dispose of the detergent package as usual, by putting it in a place reserved for plastic bags.
- Never leave used packages lying around freely accessible.

### DESCALING OF COOKING CHAMBER

Descaling is recommended when there are visible lime scale deposits in the cooking chamber (a white layer of water scale), this depends on water hardness.

To perform descaling on the RETIGO Vision combi steamers it is necessary to use a special agent called Vision Descaler. The Vision Descaler is applied in the same way as the Active Cleaner.

The standard package size for the Vision Descaler is a plastic bucket containing 25 bags weighing 100 grams each.

## 8 | ERROR MESSAGE TABLE

There could appear error messages on the display during the cooking process. Their meaning is as follows:

| ERROR         | DESCRIPTION  | SOLUTION  |
|---------------|--|---|
| <b>Err 10</b> | The minimum water level was not reached in the boiler within the set time limit despite the maximum water level being reached. | The combi oven will automatically switch to the reserve injection state and it is possible to continue using it temporarily. After the combi oven is turned off and then on again, it will attempt to put the boiler into operation. If the problem reoccurs, please contact an authorised service company. |
| <b>Err 11</b> | Chamber heating element error.   | The combi oven cannot continue operating. Contact an authorised service company.  |
| <b>Err 12</b> | The maximum water level was not reached in the boiler within the set time limit.   | The combi oven will automatically switch to the reserve injection state and it is possible to continue using it temporarily. After the combi oven is turned off and then on again, it will attempt to put the boiler into operation. If the problem reoccurs, please contact an authorised service company. |
| <b>Err 13</b> | The minimum water level was not reached in the boiler within the set time limit.   | Check the water supply inlet (open tap). The combi oven can be used temporarily only in hot air mode. If the problem reoccurs, even when water supply is provided, please contact an authorised service company.  |
| <b>Err 15</b> | Failure of motor heat protection. Signals motor overheating above the set limit.   | Kontaktujte autorizovanou servisní firmu.   |
| <b>Err 16</b> | The boiler was not preheated within the set time limit.  | The combi oven will automatically switch to the reserve injection state and it is possible to continue using it temporarily. After the combi oven is turned off and then on again, it will attempt to put the boiler into operation. If the problem reoccurs, please contact an authorised service company. |
| <b>Err 17</b> | When draining the boiler, the water level did not fall below the minimum water level within the set time limit.                | The combi oven will automatically switch to the reserve injection state and it is possible to continue using it temporarily. After the combi oven is turned off and then on again, it will attempt to put the boiler into operation. If the problem reoccurs, please contact an authorised service company. |
| <b>Err 18</b> | When draining the boiler, the water level did not fall below the maximum water level within the set time limit.                | The combi oven will automatically switch to the reserve injection state and it is possible to continue using it temporarily. After the combi oven is turned off and then on again, it will attempt to put the boiler into operation. If the problem reoccurs, please contact an authorised service company. |
| <b>Err 26</b> | Flap valve error. The automatic flap valve is not working correctly.   | Incorrect function of the flap valve may affect cooking results, however, it is possible to continue using the combi oven temporarily. Contact an authorised service company.   |
| <b>Err 31</b> | Drain heat sensor error.   | The combi oven can temporarily be used in all modes. Contact an authorised service company.   |
| <b>Err 32</b> | Boiler heat sensor error.  | The combi oven will automatically switch to the reserve injection state and it is possible to continue using it temporarily. After the combi oven is turned off and then on again, it will attempt to put the boiler into operation. If the problem reoccurs, please contact an authorised service company. |
| <b>Err 34</b> | Error of the 1-point temperature probe.  | The combi oven can temporarily be used in all modes with the exception of the modes with a temperature probe. Contact an authorised service company.  |
| <b>Err 35</b> | Chamber heat sensor error.   | Error blocks work in all modes. Contact an authorised service company.  |
| <b>Err 36</b> | Error of the 6-point temperature probe.  | The combi oven can temporarily be used in all modes with the exception of the modes with a temperature probe. Contact an authorised service company.  |
| <b>Err 37</b> | Thermistor disconnected.   | Contact an authorised service company.  |

|                  |  |   |
|------------------|--|---|
| <b>Err 38</b>    | Thermistor short-circuited.  | Contact an authorised service company.  |
| <b>Err 40</b>    | Outage of the chamber thermal fuse, boiler (only boiler combi ovens), draught interrupter (only gas combi ovens with a draught interrupter) or switchboard thermal fuse. | Contact an authorised service company.  |
| <b>Err 41</b>    | Cooling error - overheating of electronics.  | Clean the dust filter. If the error occurs repeatedly, please contact an authorised service company.  |
| <b>Err 42</b>    | Overheating of the boiler heating element.   | The combi oven will automatically switch to the reserve injection state and it is possible to continue using it. After the combi oven is turned off and then on again, it will attempt to put the boiler into operation. If the problem reoccurs, please contact an authorised service company. |
| <b>Err 60-79</b> | Modbus communications error.   | Disconnect the power supply to the combi oven (not "Standby" mode), wait 30 seconds and then turn on the combi oven again (reconnect the power supply). If the problem reoccurs, please contact an authorised service company.  |
| <b>Err 80-91</b> | Frequency converter error.   | If the problem reoccurs, please contact an authorised service company.  |
| <b>Err 95/97</b> | Incorrect blower speed.  | If the problem reoccurs, please contact an authorised service company.  |
| <b>Err 96/98</b> | Lighting up error.   | Check that the gas supply is open and reattempt to start cooking. If the problem reoccurs, please contact an authorised service company.  |



- **Equipment failures can be repaired by authorized service only, which is trained and certified by the manufacturer. Warranty does not apply in the case of improper or unauthorized service!**
- **Combi oven must be subjected to regular checks throughout the operation, tests and revisions as required by ČÚBP č. 48/1982 Coll.**

## 9 | SERVICE LIFE, TAKING OUT OF OPERATION AND WARRANTY

### SERVICE LIFE

The product's service life is 10 years if the following conditions are adhered to: A regular preventative service inspection after every 12 months of operation. This inspection must be performed by service technicians from a Retigo-authorized partner company.

The user must present a list of service events.

The user must precisely follow the instructions in the operating manual.

The user must maintain and clean the appliance daily using cleaning agents recommended by Retigo.

If the appliance has automatic cleaning, cleaning agents recommended by Retigo must be used exclusively.

Training of users by a Retigo professional cook must be documented in the service booklet or by copies of the user training log.

If operating personnel change, training must be conducted again.

### TAKING OUT OF OPERATION – DISPOSAL

For disposal of the COMBI OVEN after it has been taken out of operation, it is necessary to comply with applicable national regulations on waste disposal. The appliance contains electrical parts (electronics, transformer, halogen lamps, battery, etc.) that may damage the environment if disposed of improperly.



**The combi oven and its parts MUST NOT be disposed of in communal waste!**

The appliance's end user must choose among three of the following disposal options:

#### Disposal by RETIGO s.r.o.

Order the disposal of the equipment by RETIGO by calling the telephone number +420 571 665 511 or by email at info@retigo.cz

How to prepare the combi oven for disposal:

- Professionally disconnect the electrical equipment from the media
- Place the electrical equipment on a pallet, secure it with shrink-wrap, and transport it to an appropriate loading location.



Removal and disposal are free for the end user. In cooperation with a contracted company, Retigo s.r.o. will arrange the removal and disposal of the electrical equipment in accordance with the law in force. Likewise, Retigo s.r.o. will arrange the disposal of other companies' electrical equipment of similar type and use, if Retigo s.r.o. products are replacing them.

### Disposal by the appliance's distributor

Order disposal of the combi oven through the distributor, who will then arrange disposal with Retigo.

When ordering, provide the following information:

- exact address for picking up the combi oven
- contact person, telephone
- time for picking up the combi oven

### Disposal on your own

If you decide to dispose of the combi oven on your own, comply with applicable national waste disposal regulations. Take the appliance's sheet metal parts to an appropriate collection facility, and put the glass into recycling bins. Take ceramic insulation and electrical parts to a specialised company authorised to treat and dispose of such waste.

### WARRANTY

The warranty period is noted in the service booklet and on the warranty certificate. Demand a confirmation of the warranty from the company that installed your combi oven.

Not covered by the warranty are damage and failures caused by incorrect operation, failure to observe this operating manual, use of aggressive cleaning agents, and improper cleaning of the combi oven. Also not covered are defects caused by installation that is not in keeping with the manufacturer's recommendations, incorrect repairs, unauthorised tampering and force majeure.





# retigo<sup>®</sup>

PERFECTION IN COOKING AND MORE...

## **RETIGO**

Láň 2310, PS43

756 64 Rožnov pod Radhoštěm

Czech republic

Email: [info@retigo.com](mailto:info@retigo.com)

Tel.: +420 571 665 511

[www.retigo.com](http://www.retigo.com)

ver. TSD-15-O-MAN-US\_R01

ver. SW: 3.64